

The Initial Position and Postural Attitudes of Driver Occupants

Experimental Protocol



Ergonomics Research Laboratory
Michigan State University
East Lansing, Mi, 48824

Prepared for:
Human Factors
Delphi Interior & Lighting Systems
Warren, MI 48092-5905

REPORT DOCUMENTATION PAGE

NAME OF PERFORMING ORGANIZATION		NAME OF FUNDING ORGANIZATION	
Ergonomics Research Laboratory Michigan State University		Delphi Interior & Lighting Systems General Motors Corporation	
ADDRESS (City, State, Zip Code)		ADDRESS (City, State, Zip Code)	
742 Merrill Street Lansing, MI 48912		6600 East Twelve Mile Road, W-4 Warren, MI 48092-5905	
REPORT NUMBER		CONTRACT NUMBER	
ERL-TR-95-001		PO# FDS04345	
TITLE			
The Initial Position and Postural Attitudes of Driver Occupants. Experimental Protocol.			
AUTHOR (S)			
Herbert M. Reynolds, Raymond Brodeur, Maria Eppler, Doug Neal, Kal Rayes, Robert Kerr, George Stockman			
TYPE OF REPORT	TIME COVERED	DATE OF REPORT	PAGE COUNT
Technical	10/1/94 - 3/15/95	May 25, 1995	49
KEY WORDS			
Instrumentation, Experimental Protocol, Seat Buck, Vehicle Laboratory, Pressure Distribution, Electromyography, Seat Position			
ABSTRACT			
This report contains a description of all instrumentation, tools and procedures used in collecting data for an investigation of driver posture and comfort while operating a 1995 mid-sized vehicle and sitting in a seat buck. The investigation measured anatomical landmarks in three-dimensional space that are used to characterize seated posture with a video anthropometric system installed in the vehicle and a seat buck. It has combined these data with pressure measurements to completely define the position of the pelvis (Hpt and Dpt) while the driver is operating a vehicle on the highway. It also took standard anthropometric measurements of each of 102 subjects as well as specialized geometric data on the orientation of the chest and pelvis while measuring the position of the dorsal spines of the vertebrae in the spinal column. Each subject sat in five postures for these measurements of the spinal column. These data will be developed into a model of the human spinal column for seated postures. In addition, measurements were made of each subject while operating the vehicle as well as questionnaires that were used to investigate comfort of the driver.			

Preface

This report is the first in a series of reports documenting the research in the Ergonomics Research Laboratory, Michigan State University sponsored by Delphi Interior & Lighting Systems, General Motors Corporation (formerly Inland Fisher Guide Division). The experimental protocol has been developed through the cooperation of personnel from Delphi and the Ergonomics Research Laboratory over the course of the past three years. It represents the culmination of several years hard work and creative problem solving efforts to bring objective measures of driver posture and subjective measures of the driver's perceived comfort together into one comprehensive research program.

This research could not have been performed without the combined wisdom and experience of many people from Delphi and General Motors Corporation. In particular, we would like to acknowledge the contributions of Alicia Vertiz, MD, Manager, Human Factors, Delphi Interior & Lighting Systems. Her desire to further the general understanding of driver posture and comfort for the development of automotive seat design tools has led to the current understanding of technology and research tools that are reported in this document. In addition, the people on her staff at Delphi have contributed immensely. We would like to acknowledge the contributions in prior years of Bill Heitzeg and currently Lee Zhang, Ph.D. in their efforts to maintain liaison between Delphi and ERL.

Initially, Don Maertens, GM Mid-Size Car Division, was intimately involved and his cooperation and support by providing the vehicles used in this investigation has been critical to our progress. His involvement has been interrupted by additional activities at General Motors, but his willingness to support research that he sees as important has remained strong.

Lastly, we would like to express our appreciation to the faculty and staff at Michigan State University who have been involved in this research throughout our years of work. This includes the people in Purchasing, Contracts and Grants, and other departments within the University who have supported this program in their respective roles at the University.

Table of Contents

	<u>Page</u>
Preface.	ii
List of Figures.	iv
List of Tables.	v
I. Introduction.	1
II. Instrumentation, Questionnaires and Measurement Environments.	2
A. Instrumentation.	2
1. Metrecom.	2
2. Video Anthropometry.	2
3. Pressure Distribution System.	3
4. Seat Position System.	3
5. Electromyography	3
B. Questionnaires.	5
C. Measurement Environments.	15
1. Seat Buck.	15
2. Spine Anthropometry Seat (SAS).	18
3. Vehicle Laboratory.	21
III. Population and Sample.	24
IV. Laboratory Preparation and Subject Measurements.	27
A. Arrival of Subject.	27
B. Seat Buck Measurements.	27
C. Anthropometric Measurements.	28
D. Spine Data Collection.	29
V. Drive Protocols and Data Collection	30
A. 20 Minute Drive.	30
B. Fixed Seat Back Drive.	30
C. Free Drive.	31
VI. Summary of Reports and Expected Results.	32
VII. List of References.	37
Appendix	
A Correspondence with Subject (including Consent Form).	38
B Questionnaire.	47
C Map of Drives.	51
D Experimental Protocol.	53

List of Figures

<u>Figure</u>		<u>Page</u>
1	Electrode placement for measuring muscle activity in driver.	4
2	Position of body for normalizing EMG amplitudes.	4
3	Verbal questioning during drive.	6
4	Seat evaluation questionnaire.	7
5	Post drive questionnaire.	10
6	Evaluation questionnaire.	13
7	Coordinate system in seat buck and vehicle laboratory.	16
8	Schematic of Spine Displacement Transducer (SDT).	16
9	Subject seated in Seat Buck.	17
10	Anthropometric landmarks on subject in SAS axis system.	19
11	Subject seated in spine anthropometry seat (SAS).	20
12	Flow chart for data collection in vehicle laboratory.	23

List of Tables

<u>Table</u>		<u>Page</u>
1	Distribution of original R. L. Polk sample by age and sex.	24
2	Distribution of laboratory subjects by sex, age group, stature group and sample size. . . .	25
3	Distribution of drive subjects by sex, age group, stature group and sample size.	25
4	Vehicles owned and driven primarily by drive subjects.	26
5	Fixed seat back drive data collection protocol.	31
6	Free drive data collection protocol.	32

The Initial Position and Postural Attitude of Vehicle Operators

Experimental Protocol

I. Introduction

This research investigation measured subjects operating a vehicle, sitting in a seat buck, and sitting in a variety of spinal postures. Data from these measurements were collected to describe the comfort of the vehicle operator for seat design, the development of a model of the spinal column in vehicle operators, and a test of the model with independent measures of spinal curve in the seat buck. The goal of this research was to objectively measure posture, pressure, and muscle activity and to correlate these to subjective responses to written and verbal questionnaires about an automotive seat and vehicle environment. The purpose of the present report is to describe the instrumentation and experimental protocol that was followed in the laboratory and vehicle.

In the laboratory, data on 102 subjects were collected at three stations: a) seat buck measurements, b) anthropometric measurements and c) spinal contour-posture measurements. The seat buck consists of the interior of a Pontiac 6000 from the engine compartment to just posterior to the B pillar. The driver's side seat and environment were fully intact but modified to enable the measurement of posture using a video camera system (video anthropometry) and with the seat modified to allow the measurement of spinal contour, seat back deformation and pressure distribution in the seat. Since body size is an important factor to consider in seat design and comfort, subjects were selected to represent the full spectrum of body types and anthropometric measurements were essential for this study. In the vehicle laboratory we have developed techniques for measuring the position of the pelvis and chest of a subject, but we are unable to directly measure spinal contour. Thus the spinal contour-posture measurements were designed to enable us to generate a spinal model that accurately predicts lumbar contour based on chest and pelvis position.

The vehicle laboratory is designed to measure seat position, steering wheel position, subject posture, subject muscle activity and pressure distribution in the seat pan and seat back during highway driving. All of these measurements are made in a non-invasive manner, with the safety of the subject having the highest priority. Data is collected at specified intervals during a drive, without the subject being aware of the data collection process. All measurement systems are controlled by a single onboard computer operated by a technician sitting in the back seat of the car.

The following report will describe the equipment and experimental protocol. This report describes the procedures that were followed throughout the complete study covering a period of approximately six months data collection. Additional reports will follow as listed in the last section, but the complete overview of the research investigation is presented within these pages.

II. Instrumentation, Questionnaires and Measurement Environments

A. Instrumentation

The primary instrumentation used in this study were the Metrecom by FARO Technologies, a pressure mat system by Tekscan, an electromyography system by Bioresearch and a video anthropometry system developed in-house. These measurement systems are described below.

1. Metrecom

The Metrecom was the standard of reference for measuring three-dimensional points. It is a six degree of freedom electro-goniometer that is capable of measuring the three-dimensional position of a point with an error less than 0.1mm for the experimental volume defined for this study. This tool served three major purposes. First, it provided a means of accurately measuring the three-dimensional position of anatomical landmarks on a subject for many of the laboratory measurements. Second, it provided a quick and reliable means of establishing a repeatable and physically meaningful three-dimensional coordinate system for each of the measurement environments. Finally, it was an accurate and flexible tool for measuring points on the calibration structure used to define the direct linear transformation matrix for the video anthropometry system.

2. Video Anthropometry

The video anthropometry system is composed of four video cameras mounted in the vehicle laboratory or seat buck in standardized locations. The cameras provide a means of measuring the three-dimensional position of any point that lies in the field of view of at least two of the cameras. Using this method, targets on a subject can be measured in a safe and noninvasive manner during actual highway driving.

The four CCD cameras have 4.8mm auto-iris lenses to obtain a complete view of each driver regardless of their body size or where they position their body in the vehicle driving package. The cameras are as small as possible to be unobtrusive and minimize interference with the driver's vision. The four locations and the associated camera # in the system are as follows:

Camera	Location
1	Dome light fixture
2	A pillar above dashboard
3	A pillar below dashboard
4	B pillar, middle of window opening

Attached to the lens of each camera is an array of infrared (IR) LED's. Camera #1 has 60 IR LEDs and all other cameras have 100 IR LEDs. A notch filter to pass only IR wavelength was installed on each camera lens. Due to the high levels of IR in normal sunlight, the complete interior of the vehicle and detail of the operator was clearly visible in all images.

Images from the four cameras are multiplexed by a Matrox frame-grabber board in an IBM compatible 486. All camera images are collected in 0.13 seconds and stored in the Matrox buffer for review by an observer before being written to the hard disk for permanent storage.

A generalized stereo algorithm was utilized to develop the software for image analysis. Before collecting any subject data, a calibration structure is installed in place of the seat in the seatback or vehicle. The position of targets on this calibration structure are measured with the Metrecom in a world axis system defined at the base of the calibration structure. Images of this calibration structure are recorded from each of the cameras. By knowing the true three-dimensional positions of points on the calibration structure and measuring the same points on each camera image, the position of each camera can be determined in the world axis system. Once each camera is calibrated to this field of view, a 3 x 4 matrix algebraically represents the perspective imaging transformation of a ray passing from the camera through a target in this imaging space. When two or more cameras observe the same target and define rays that intersect at the location of the target, the three-dimensional coordinates can be calculated using direct linear transformation. This calibration procedure is only repeated when one of the cameras is moved.

3. Pressure Distribution System

Tekscan pressure mats are used to measure contact area and body pressure distribution (BPD). Two types of mats were used in this project. The larger mats (381mm X 457mm with 5mm X 5mm square sensors on 10mm centers) were used in the seat pan and the seat back of the vehicle laboratory. This type of mat was also used in the seat pan of the seat buck. Smaller (112mm X 112mm with 1.2mm X 1.2mm sensors on 2.5mm centers) mats were used to measure pelvis contact area in the spine anthropometry seat (see below).

4. Seat Position System

The seats in both the seatback and vehicle laboratory had six-way power and power recline. To track the seat position movements made by the subject, two different devices were used: linear potentiometers and inclinometers.

Linear potentiometers were used to measure translational changes in seat position, such as fore/aft and up/down directions. Changes in the lumbar support, both the up/down and in/out directions, were also measured using the linear potentiometers. These potentiometers were attached to the drive cables, so that resistance was changed when the seat was moved. The resulting resistance was converted to a voltage that was measured by the laboratory computer. Each measured direction of the seat required a separate channel of data collection. To convert this voltage to the seat's actual position, a calibration for each channel was performed. A computer program calculated the actual seat position.

Inclinometers (Midori PMP S30T) were used to measure angular changes in seat position, such as seat back angle, steering wheel angle, and vehicle angle. The inclinometers output a voltage, and that voltage changes as the angular orientation of the inclinometer changes. This voltage is then converted to a digital signal that is used in a program to calculate the angle.

5. Electromyography

An 8-channel Biopak electromyography (EMG) system (Bioresearch, Inc.) was used to measure muscle activity and muscle fatigue characteristics. The Biopak system uses state-of-the-art EMG technology, including an optical isolation system to protect the subject from accidental electric shock. For this study we monitored the activity of the muscles illustrated in Figure 1.

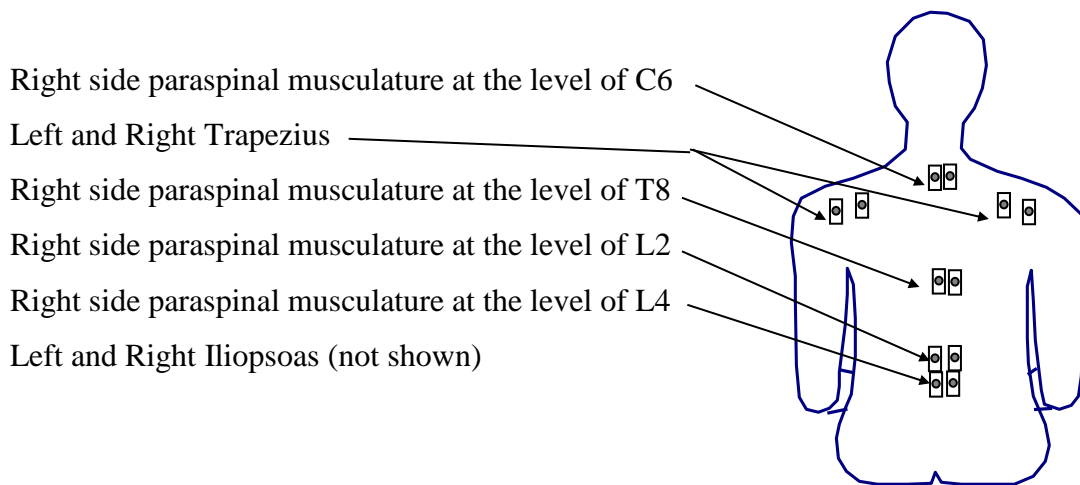

Figure 1. Electrode placement for measuring muscle activity in driver.

The EMG signal was calibrated relative to the subject's ability to lift their trunk to a maximum extended posture. The subject lay prone as shown in Figure 2. A resting EMG signal was recorded to provide information on resting muscle activity as well as to determine the level of noise in the signal. The subjects were asked to lift their head and extend their back as high as possible. This provided base-line data for the EMG amplitude as well as for the median frequency. A more complete description of EMG methods will be described in the report "Driver Muscle Activity" (see section VI).

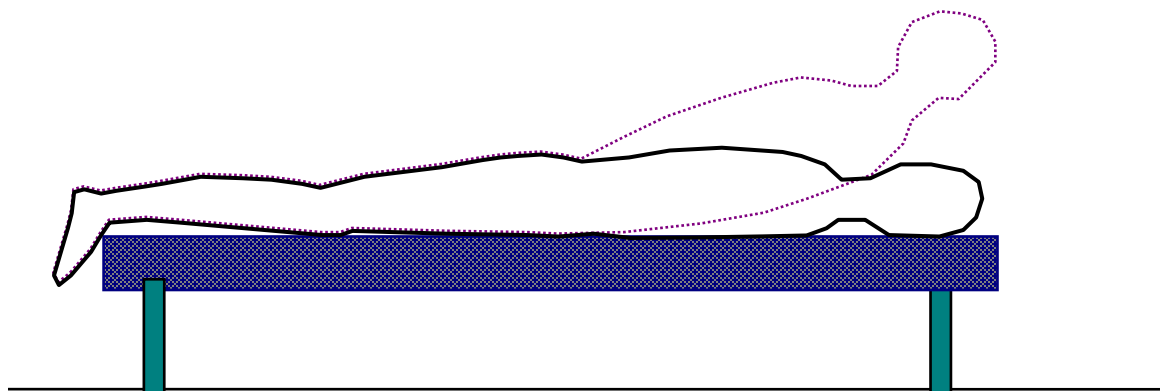

Figure 2. Position of body for normalizing EMG amplitudes.

B. Questionnaires

Verbal Questioning During Drive. This questionnaire was given to the subject orally by the Ride Tech during the test drives. The questionnaire was administered whenever the

subject indicated discomfort or adjusted the seat. If the subject did not indicate discomfort or adjust the seat, the ride tech administered the questionnaire at set time intervals. This questionnaire, along with all comments made by the subject during driving were recorded on tape. The transcription of this tape is being analyzed for content regarding comfort and discomfort, particularly for the sources of discomfort described by the subject during the drive. (p. 6)

Seat Evaluation Questionnaire. This questionnaire was administered to the subject in the test vehicle at the end of each test drive. This questionnaire allowed the subject to state his/her perceptions of specific seat features and then rank their level of like or dislike of the feature. (p. 7)

Post Drive Questionnaire. This questionnaire was administered to the subject in the test vehicle at the end of each test drive. Subjects were asked to record body regions in which they were experiencing any discomfort. A map of the body, numerically coded by region, was used by the subject to indicate the region of the body discomfort. The subject then ranked the level of discomfort and wrote a description of the sensation felt in that particular region. (p. 10)

Evaluation Questionnaire. The evaluation questionnaire was administered at the end of each test period, whether the subject was driving was only being measured in the laboratory. It allowed subjects to evaluate the test clothing, the staff and the test procedures. Subjects were also asked to make suggestions that would improve the study. There were different questionnaires used for different subjects and different activities such as the fixed back drive, these may be found in Appendix B. (p.13)

Figure 3. Verbal Questioning During Drive

1. Before the subject enters the car record on the tape:

Subject #
Drive (20 min., spine or free)
Date
Time of Drive

2. If the subject states that they are uncomfortable or it is time to administer the verbal question:

Time

Where are you experiencing discomfort?
(If it is more than one location on the body or more than one condition in the vehicle, administer the ranking scale for each discomfort mentioned)

Ask them to rank the level of discomfort

**On a scale of 0 to 10 with 0 being the lack of discomfort
1 being slightly uncomfortable and increasing until 10
which is most uncomfortable please rank you level of
discomfort.**

After the ranking, probe for the follow information

Location (If they mention the left leg ask if it is the thigh or calf?
is it on the bottom or the top of the leg?)

Description of what are they feeling? tingling, fatigue, etc.

Figure 4. Seat Evaluation Questionnaire

Date: _____ ID# _____

m d y

Sex: **M** **F**

Please (/) on the scale below the response that best fits your description of the seat.....then place a slash (/) on the scale below to let us know how you feel about this characteristic.

1. My posture in this seat is...

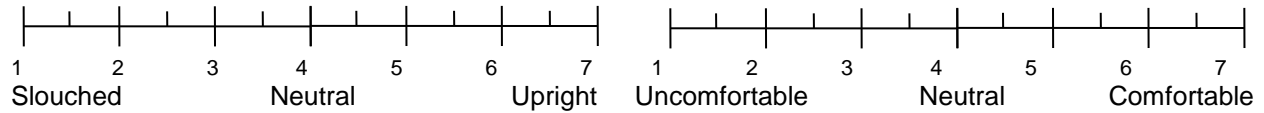

2. The feel of the seat back is...

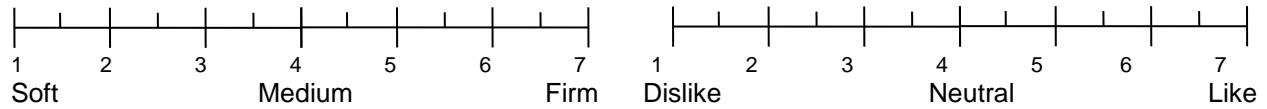

3. I sink into the seat back...

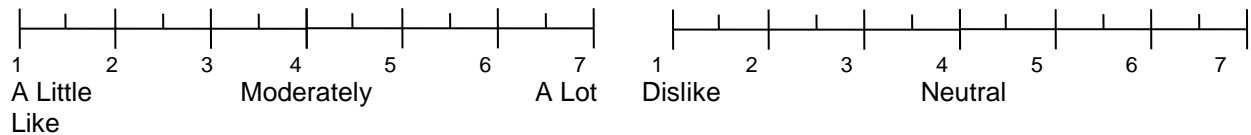

4. The height of the seat back is...

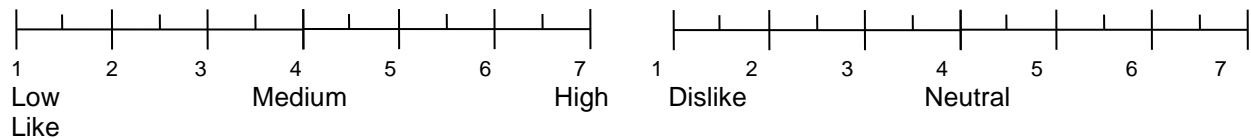

5. The width of the seat back is...

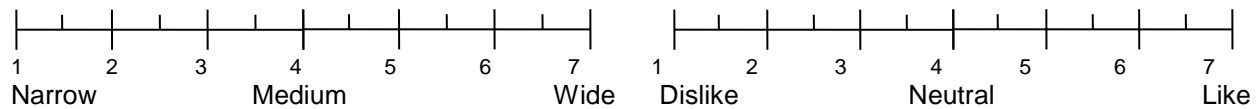

6. The angle of the seat back is...

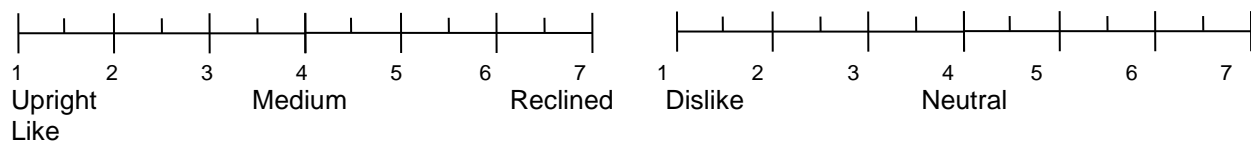

7. The up and down position of the lumbar support is...

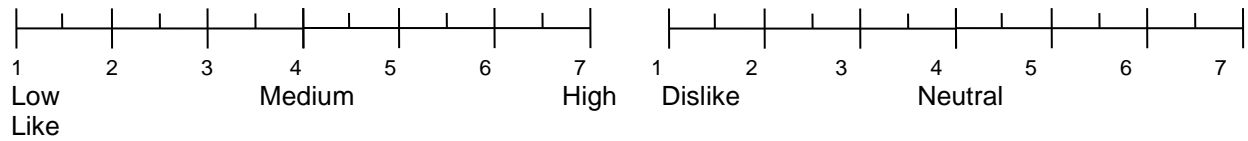

8. The in and out position of the lumbar support is...

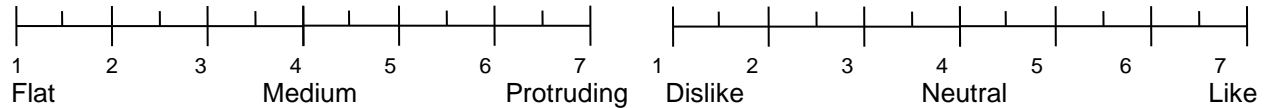

9. The feel of the seat cushion is...



10. I sink into the seat cushion... _

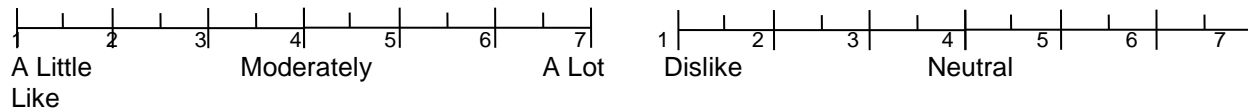

11. The length of the seat cushion is...

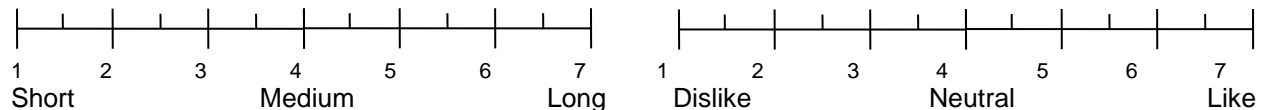

12. The width of the seat cushion is...

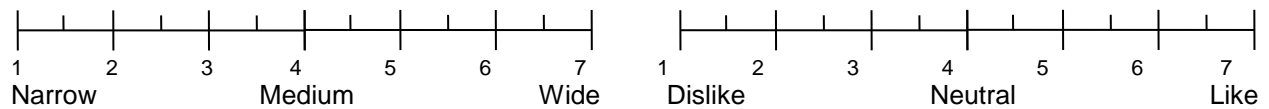

13. The angle of the seat cushion is...

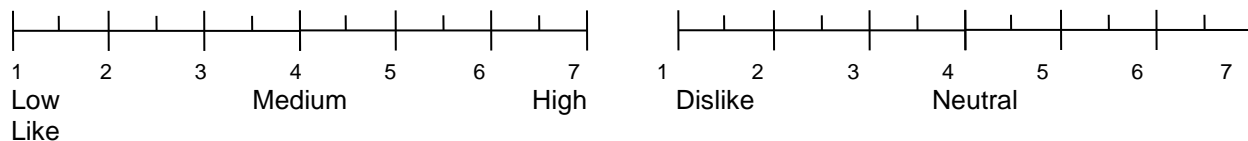

In Front

In Front

14. The height of the seat cushion from the floorboard is...

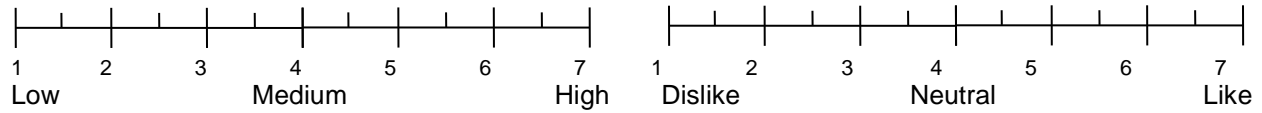

15. My vision through the front window is...

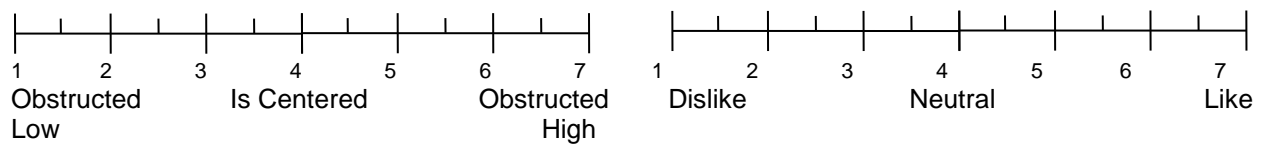

16. The shoulder belt against my neck ..

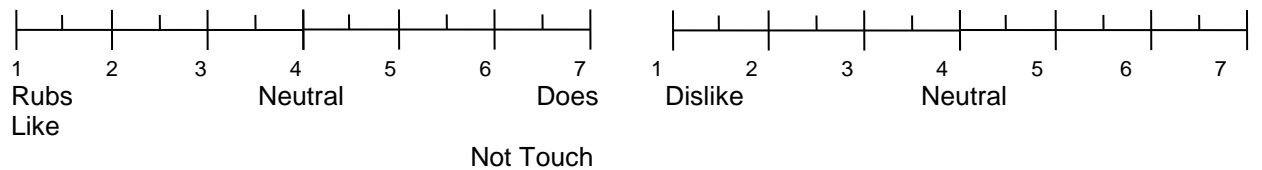

17. The distance of the roof from my head is ...

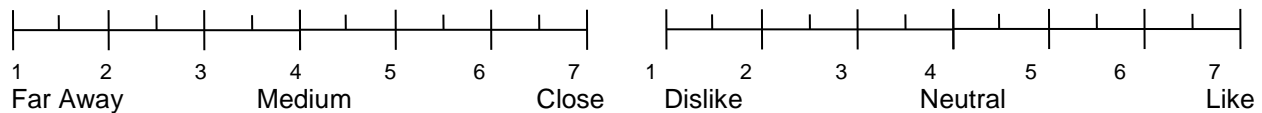

18. The distance of the steering wheel from my body is...

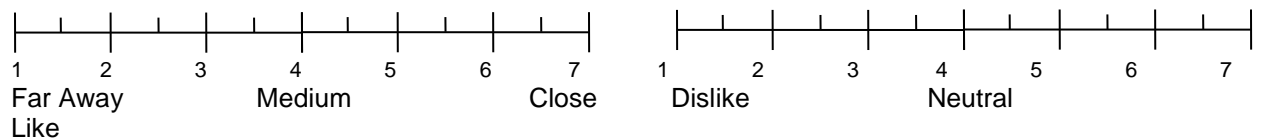

19. The distance of the foot pedals from my body is...



Far Away
Like
Away

Medium

Close

Dislike

Neutral

20. How do you feel about the seat overall?.

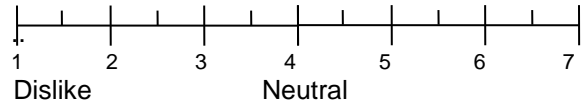

Like

Figure 5. POST DRIVE QUESTIONNAIRE

Date: _____ ID#

Please use the diagram of the of the body below to identify areas on your body that you experienced discomfort. On the following sheet, starting with the region that you experienced the most discomfort, please write:

- 1. The numerical code of region as well as specify the body region (i.e. the elbow, knee, etc.);*
- 2. Mark the level of discomfort on the scale provided; and*
- 3. Describe any sensations that you felt in that particular body*

region

(i.e. numbness, stiff, too hot, tired, etc.)

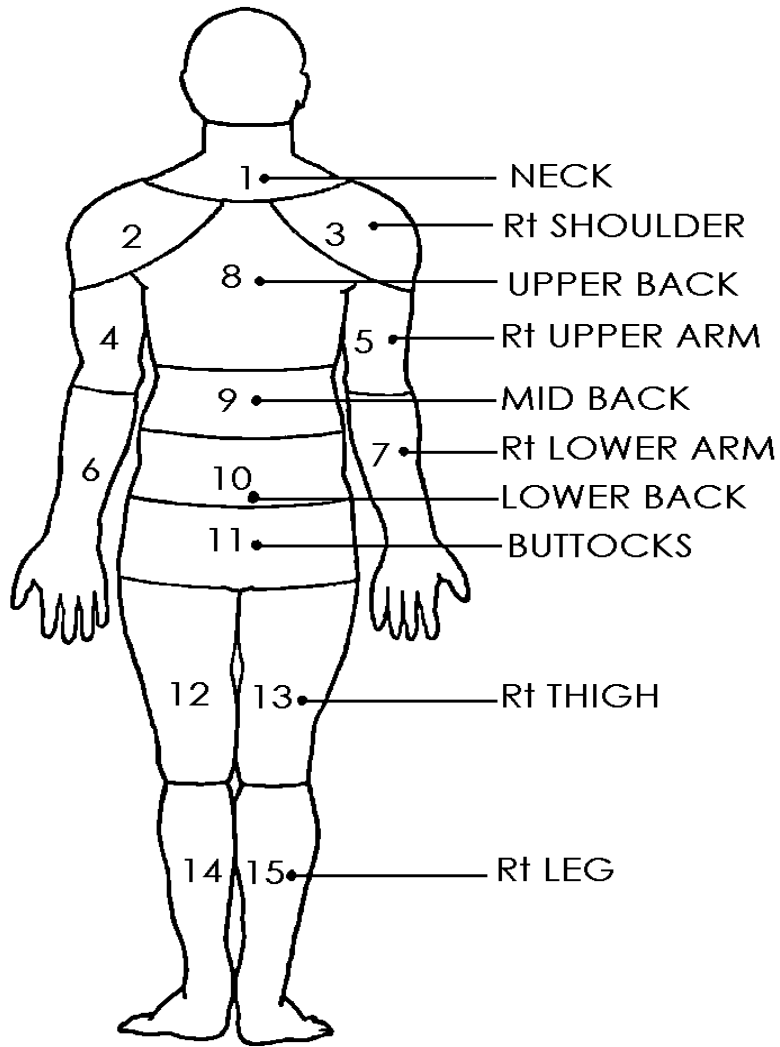

Date: _____ ID#

1. Numerical code & description of body region: _____

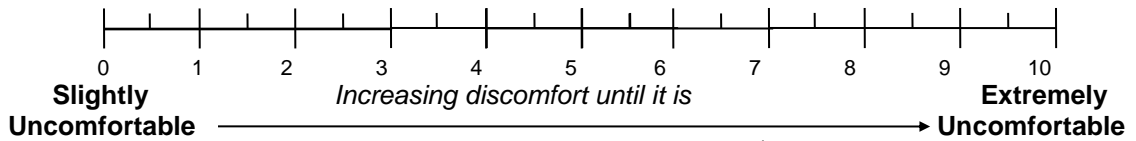

Please describe any sensations that you are feeling in this body region:

2. Numerical code & description of body region: _____

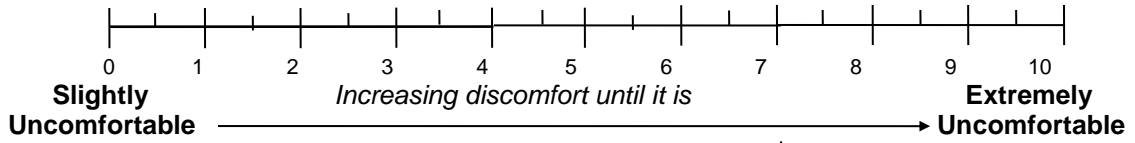

Please describe any sensations that you are feeling in this body region:

3. Numerical code & description of body region: _____

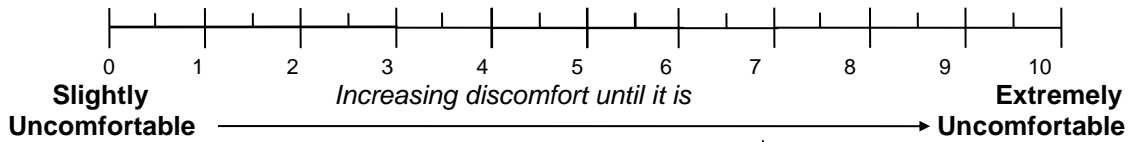

Please describe any sensations that you are feeling in this body region:

Date: _____ ID#

4. Numerical code & description of body region: _____

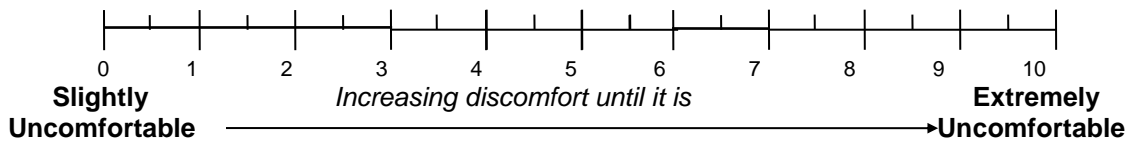

Please describe any sensations that you are feeling in this body region:

5. Numerical code & description of body region: _____

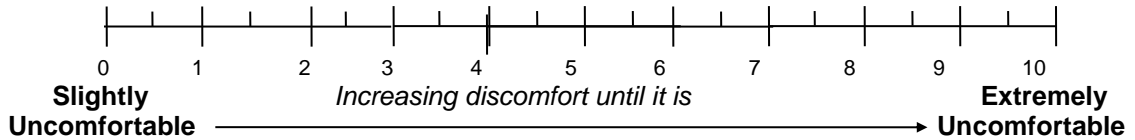

Please describe any sensations that you are feeling in this body region:

6. Numerical code & description of body region: _____

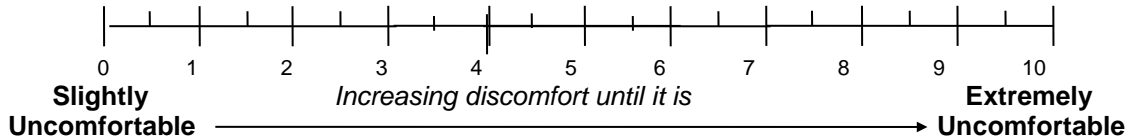

Please describe any sensations that you are feeling in this body region:

Evaluation Questionnaire

Date: _____ ID#
m d y

1. **Fit and feel of the Tank Top** (*Circle as many answers as are appropriate*)

Too Loose Good Fit Too Tight Scratches Clings
Discomfort in seams Irritation due to Label Doesn't Breathe

Please rank the Tank Top overall...

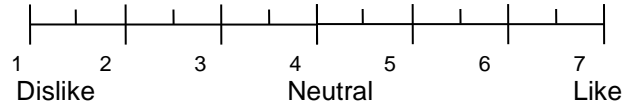

2. Fit and feel of the Bike Shorts *(Circle as many answers as are appropriate)*

Too Loose Good Fit Too Tight Scratches Clings
Discomfort in seams Irritation due to Label Doesn't Breathe

Please rank the Bike Shorts overall...

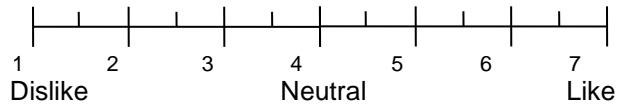

3. Did the Ride Techs work in a professional manner? YES NO

Please Comment: _____

4. Did the Lab Staff work in a professional manner? YES NO

Please Comment: _____

Date: _____ ID#
m d y

5. Did any procedures used during the testing make you uncomfortable? YES NO

Please Comment: _____

6. **Were your responses to the written and/or verbal questions influenced by the study and/or its personnel?** Yes No Please Comment: _____

7. **Please let us know if there is any way in which we can improve our study:** _____

Thank you!

C. Measurement Environments

1. Seat Buck

A 1992 Pontiac 6000 was obtained from General Motors Corporation. The engine compartment forward of the fire-wall was cut off and the rear of the car from just behind the B-pillar was also cut off. The remaining interior with roof, windshield and front doors still operable was mounted on a platform. The cut surfaces were cleaned, and all edges were finished for appearance and safety. The passenger seat was removed.

The seat that was placed in the seat buck was originally a six-way adjustable AM6 W seat with a power seat back recliner. To simplify the analysis procedure, all angular adjustments were rendered inoperable. This stipulation included using a fixed seat back and also eliminated the front and rear tilt switches. The subjects were still allowed to make adjustments in both the fore/aft and the up/down directions. For the seat buck measurements of seat position, three different displacements/channels were measured: (1) fore/aft displacement, (2) front riser height, and (3) rear riser height. Since these displacements are only linear translations, only linear potentiometers are used. The subjects did not have independent control of the front and rear risers, but these values are still measured on different channels, since they are driven by separate motors.

Four CCD video cameras were installed as previously described. The seat back was modified with a series of spine displacement transducers (see below) and the cushion upholstery had a zipper installed around the outer edge of the seat foam so that a pressure mat could be inserted between the upholstery and foam.

Location of the pressure distribution mat was measured with a semi-rigid structure that when loaded in the seat cushion defined at least three pressure cells in the pressure mat. Points on this structure were measured with the Metrocom to define the unloaded seat surface contour in 3d space. These points were defined by 20 bolts mounted on a flexible wooden matrix that consisted of four rows and five columns. The bolts were placed at each node of the matrix, approximately 10 cm apart in the X and Y directions. A series of hinged joints attached the wooden segments to provide flexibility to approximately match the unloaded seat contour.

Coordinate System. Since the Metrocom had to be moved to different stations during a laboratory measurement session, the coordinate system in the seat buck had to be re-established before every measurement session. All data were measured with respect to a coordinate system defined relative to the seat attachments to the seat buck floor as shown in Figure 7. The following points were measured with the Metrocom and used to define the seat buck axis system:

1. **Right rear seat bolt** to establish the origin
2. **Right front seat bolt** to define the X axis
3. **Left rear seat bolt** to establish the X-Y plane.
4. The cross product of the X axis and a point on X-Y plane was used to define the Z axis.

The above coordinate system was physically meaningful with respect to the seat and the subject and it was easily and accurately re-defined for each measurement session so that the effects of moving measuring equipment were minimized.

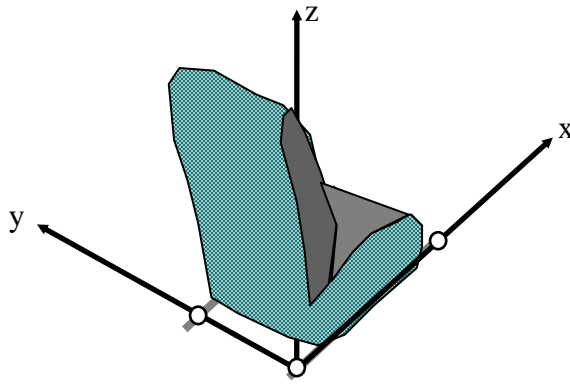

Figure 7. Coordinate system in seat buck and vehicle laboratory.

Spine Displacement Transducers. The seat back in the seat buck was modified so that we could measure both the contour of a subject's spine as well as the deflection of the foam. Steel rods were placed inside a plastic sleeve with a spring attached so that the rods were forced forward by the spring (Figure 8). A series of these were placed in the center line of the seat back so that they contacted the spine of a subject sitting in the seat (see Figure 9), allowing us to measure spinal contour.

The anterior portion of the plastic sleeve of the spine displacement transducers (SDT) were glued to the foam of the seat back. The lengths of the plastic sleeves and the rods were known. By measuring the position of the most posterior point on the rod and a point on the back of the plastic sleeve, we could determine the position of the front of the foam and also determine the position of the front of the rod. Thus, we could measure foam shape as well as spine contour.

The SDT's were measured before each subject arrived to provide a base-line for the foam shape in the unloaded state. Measuring the SDTs after the subject was seated gave the shape of the foam in a loaded state. Thus, foam deformation was measured for each subject.

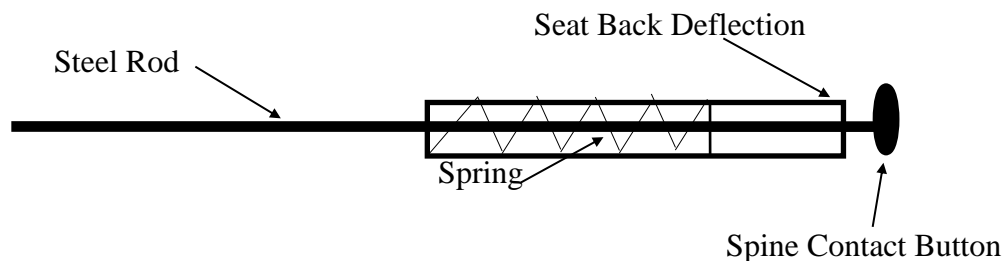

Figure 8. Schematic of Spine Displacement Transducer (SDT).

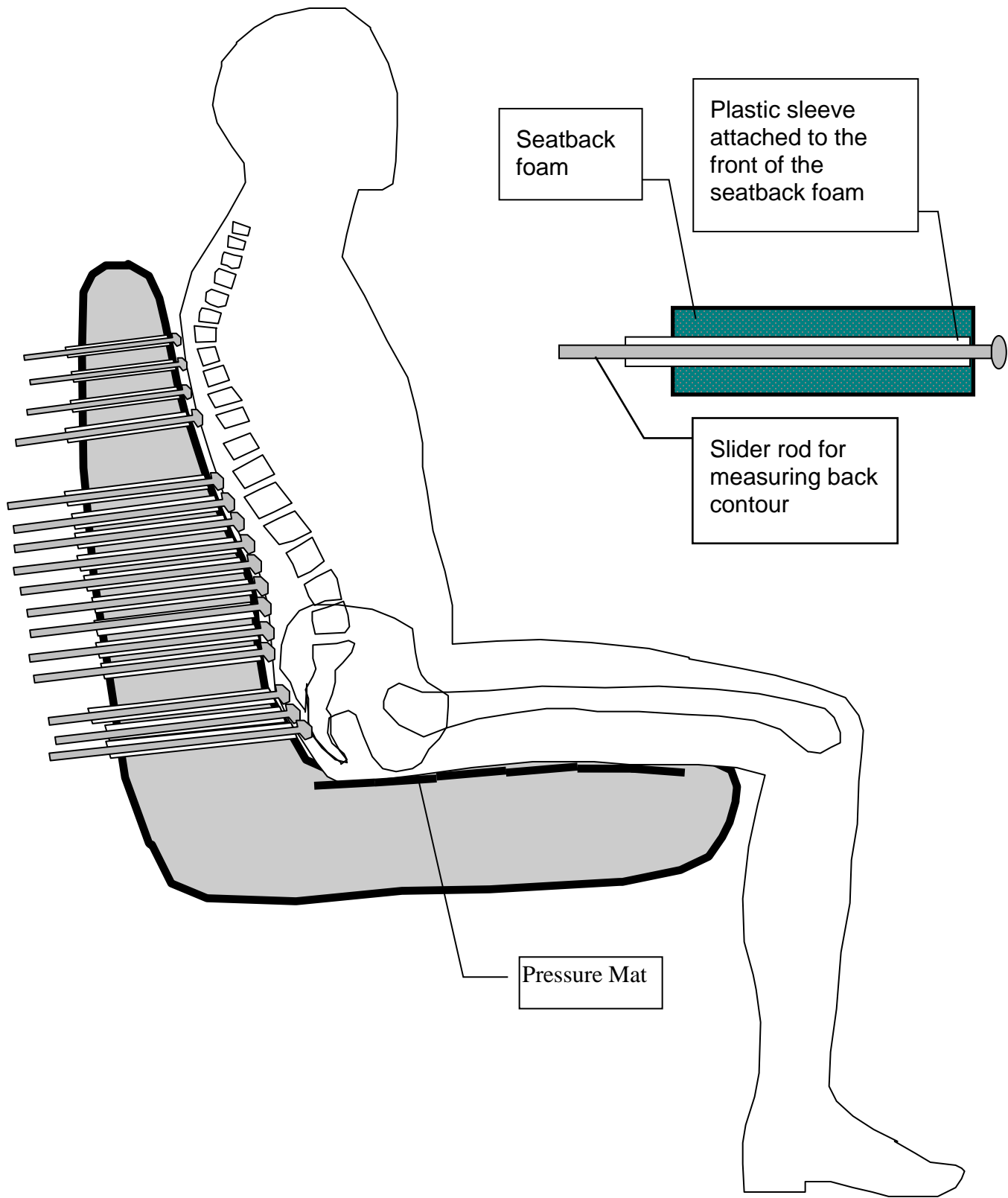

Figure 9. Subject seated in seatback.

2. Spine Anthropometry Seat (SAS)

The spine anthropometry seat was used to take anthropometric measurements and for measurements for developing a model of the spinal column that predicts lumbar contour in different seated postures.

Coordinate System. The Metrocom was used for all SAS measurements. Since the Metrocom was moved between two measurement stations for each subject's laboratory session, the coordinate system had to be quickly and accurately redefined. The origin was 14.5 cm behind the seat back of the SAS in the anthropometric measurement orientation and lying approximately on the mid-sagittal plane as shown in Figure 10. The +Z axis was directed upward, perpendicular to the horizontal seat surface. +X was defined in a forward direction and +Y was defined in a left lateral direction. Thus, a right-handed, orthogonal axis system was defined that corresponded to the axes of the cardinal anatomical planes of the body (i.e. sagittal, frontal, and transverse).

Anthropometry Seat. For anthropometric measurements, subjects were placed in a standardized position as shown in Figure 10. The height of the seat was adjustable so that the knee angle could be set at 90° for all subjects. The Metrocom was used to measure the three-dimensional coordinates of the following anatomical landmarks:

1. Vertex.
2. Ectocanthus (lateral aspect of the eye).
3. Acromion.
4. Back of elbow.
5. Inferior aspect of elbow.
6. Tip of longest finger.
7. Top of knee.
8. Front of knee.
9. Popliteal fossa.
10. Back of buttock.
11. Top of seat.
12. Floor.
13. Right shoulder.
14. Left shoulder.
15. Right ASIS.
16. Left ASIS.
17. Right Hip.
18. Left Hip.
19. Suprasternale

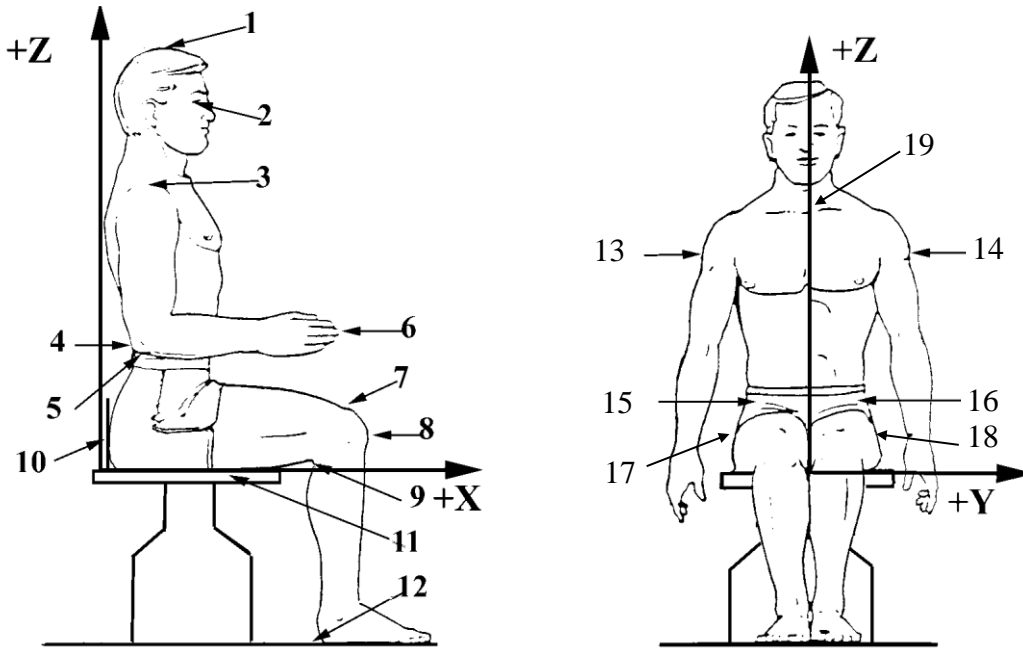

Figure 10. Anthropometric landmarks on subject in SAS axis system.

Spine Seat. The SAS was designed to be quickly converted to an orientation for spine contour measurements (see Figure 11). In this orientation, the SAS was designed to control the chest position relative to the pelvis and allow the measurement of body posture as well as spinal contour. Two 112mm X 112mm pressure mats were placed side by side in the plane shown in Figure 7. The pressure mats were used to measure the area of contact and the position of the ischial tuberosities of the pelvis.

A seat belt was combined with the pelvic plate shown in Figure 11 to hold the subject's pelvis in a single fixed posture. The chest position was varied to allow different postures and hence different spinal contours. Subjects were placed in five postures:

1. Neutral
2. Extension
3. Slumped 1
4. Slumped 2
5. Slumped 3

These postures represent the full range of positions for a subject in a driving posture. The three-dimensional coordinates were measured for points on the thigh, pelvis, chest and spine for each of the five postures. This data will be used to develop a model that predicts spine contour based on the assumption that the spine contour is dependent on the position of the chest relative to the pelvis.

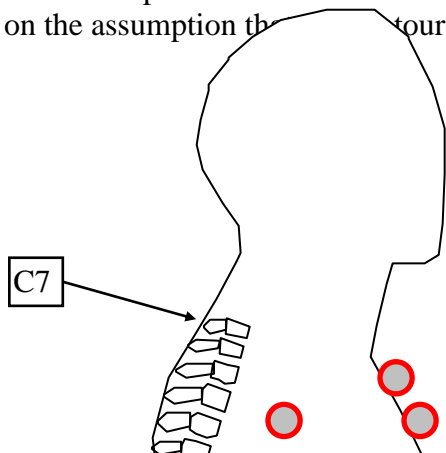

Anatomical Landmarks Collected for the Spinal

Link data:

Knee

Hip

ASIS

PSIS

Shoulder

Suprasternale

Sternum 2

Spinous processes of:

C7 T12

T2 L1

T4 L2

T6 L3

T8 L4

T10 L5

Figure 11. Subject seated in spine anthropometry seat.

3. Vehicle Laboratory

Coordinate System. All data were measured with respect to a coordinate system defined relative to the seat attachments to the car as shown in Figure 7. The following points were measured with the Metrecom and used to define the seat axis system:

1. **Right rear seat bolt** to establish the origin
2. **Right front seat bolt** to define the X axis
3. **Rear left seat bolt** to establish the X-Y plane.
4. The cross product of the X axis and a point on X-Y plane was used to define the Z axis.

This coordinate system was used to define the orientation of the video camera calibration structure. The three-dimensional coordinates of all targets visible in all video cameras were defined relative to the seat coordinate system. This coordinate system was physically meaningful with respect to the seat and the subject.

Modifications to Vehicle. Seat Belts. The restraint system for the vehicle operator was modified to a four-point system. The lap belt buckle was attached to the base of the driver's B pillar and the tongue came from an inertial reel attached to the passenger's side 3-point harness bolt. The shoulder belt tongue was attached to the driver's B pillar base inertial reel and the buckle was attached to the driver's side 3-point harness bolt on the floorboard behind the seat.

Seat. The seat used in the vehicle laboratory was originally a Pontiac AM6 W seat. This seat had six-way adjustment capability with a power recliner. The seat back was modified to include a four-way mechanical Schukra lumbar system. The seat also had a longer seat track, allowing for extended travel capabilities in the fore/aft directions. This extended track gave the seat an additional 31.75 mm of fore/aft travel (12.70 mm in front and 19.05 mm in back).

Data Acquisition System. All data collection systems were controlled by a single IBM compatible 486 computer. Figure 12 shows the flow chart that highlights the major system components and the role of the ride technician during data collection. There were four major systems for data collection:

1. Video Anthropometry (4 video cameras).
2. Pressure mats (2).
3. Electromyography (EMG).
4. Seat Position System

All data collection was controlled by the ride tech with the exception of seat position which was when the driver changed seat position. The infrared (IR) LEDs were turned on by the computer just prior to grabbing a video image. Four video images were grabbed from four cameras in 0.13 sec. The ride tech would review each image before saving the set of images to the hard drive. If image quality was not acceptable, or if a target was not visible, the images were grabbed again, and the process was repeated. Images of the pressure distribution were also viewed by the ride tech prior to saving on the hard disk. If any problems were noted by the ride tech, the pressure mat data would also be re-collected. There was a continuous recording of the video image from camera #4 to provide a complete record of the drive. Time coding was inserted on the image to provide a standard reference for each image relative to the beginning of the drive.

Seat Position System. The seat position measurement system used in the vehicle laboratories was like the one used in the seat buck. The seat buck system only recorded the fore/aft and up/down positions of the seat. The vehicle system also measured these positions plus five additional measurements. These additional measurements included two more linear displacements: lumbar in/out and up/down; and three angular displacements: seat back angle, steering wheel angle, and vehicle angle.

During one of the comfort drive protocols, the seat back angle was fixed in one of two predefined positions. Subjects could adjust all other seat controls, but the seat back angle was held constant. To control the seat back angle, a custom designed circuit was used. This circuit used a series of differential amplifiers to compare the desired seat back angle versus the actual seat back angle. This comparison was made relative to the angle of the vehicle with respect to horizontal. By accounting for the angle of the vehicle, the seat back angle was not coupled to the angular position of the car in the world coordinate system.

The following is a list of the additional equipment in the vehicle laboratory that was not described:

1. Analog Signal Processing Unit - Processes all analog signals: EMG, Inclinometers, translational seat positions. Controls fixed back angle and IR light sources.
2. Power Inverter - Converts 12 VDC to 120 VAC power for VCR and computer.
3. Auxiliary Power Source - Provides power for all 12 Volt circuitry and power inverter.
4. Video Camera Remote Units - camera circuitry for CCD camera heads in auto interior.
5. Sync Source - Provides composite sync signal for all cameras and video card.
6. Video Titler - Adds title information to Camera #4 image: Date, Time, Subject & Drive #.
7. Video Distribution Amplifier - Provides required signal strength and isolation for camera #4 to drive VCR and camera.

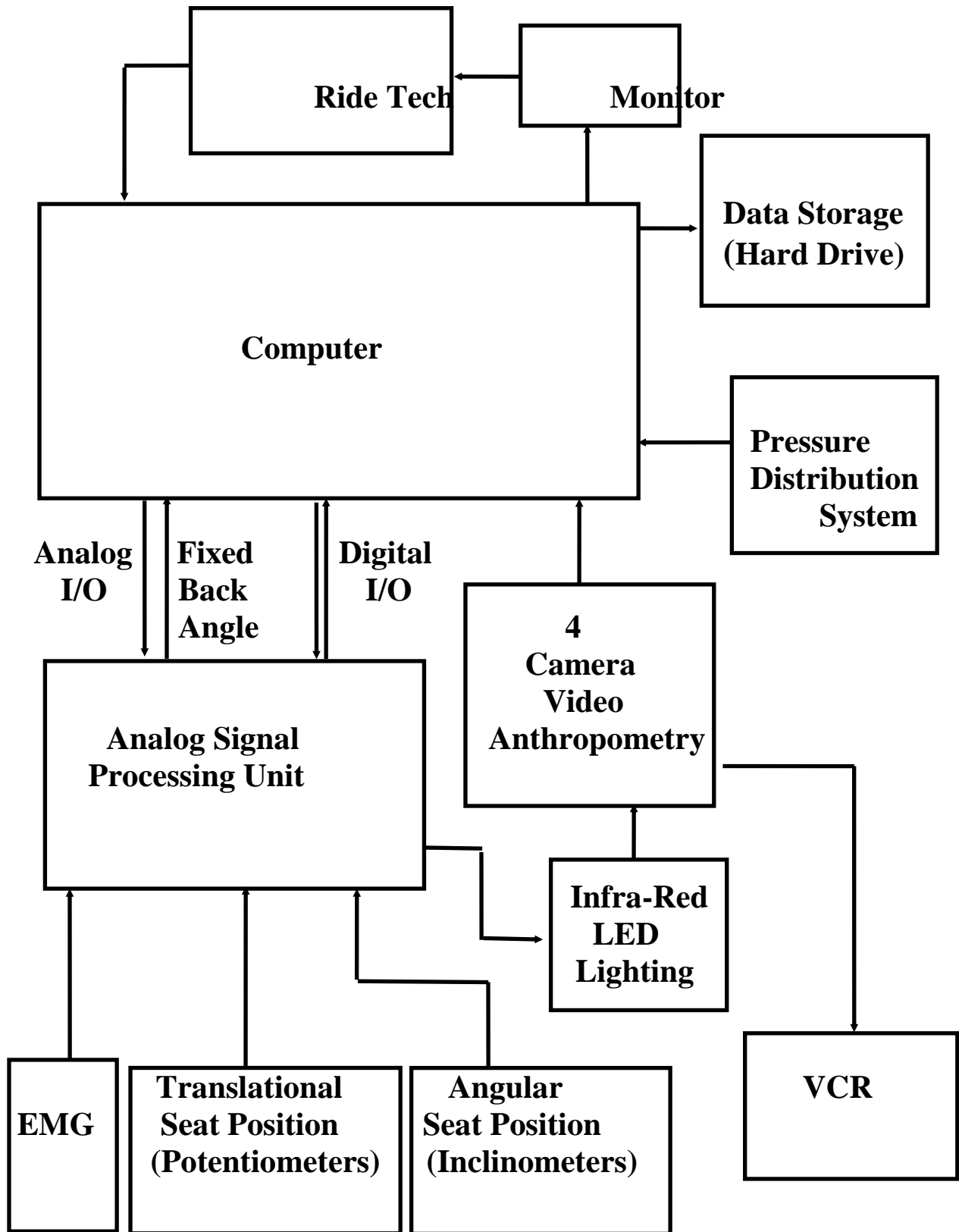

Figure 12. Flow chart for data collection in vehicle laboratory.

III. Population and Sample

To create a database of potential subjects, 800 names were purchased from the Marketing Services Division of R.L. Polk & Co. according to the following criteria:

1. Individuals who purchased a vehicle in the years of 1992-1994 from the Upper Middle and Upper Middle Specialty vehicles in the market.
2. An even number of males and females
3. An even number of subjects born in the period of 1924-1946 and the period of 1945-1969
4. The name, address and phone number of each subject
5. Data on the subject's vehicle
 - a. Manufacturer (included both foreign and domestic)
 - b. Model (Midsize only)
 - c. Year (1992-1994)

R.L. Polk found 777 subjects that met these criteria: 417 females and 360 males (Table 1). Initial contact was made to subjects via telephone. However, given the poor response rate using this method, it was decided to contact subjects via mail. A cover letter (See Appendix A) accompanied by a return postcard was mailed to approximately 750 subjects. The cover letter gave background information (i.e., who is conducting the research), expressed the purpose of the study, and stressed the confidentiality of the responses. The postcard contained 5 questions that were used to identify participants who were willing to participate in the study. One-hundred seventy-five individuals expressed interest in participating in the drive portion of the study. While the study was initially restricted to those subjects contained in the Polk database, respondents passed on information about the study to friends, relatives and associates. As a result, an additional 95 persons indicated their interest in participating in the study, thus bringing the subject pool to 270.

Age	Sex		Total
	Female	Male	
25-34	84	71	155
35-44	81	77	158
45-54	76	69	145
55-64-	86	69	155
65-74	90	74	164
TOTAL	417	360	777

Table 1. Distribution of original R.L.Polk sample by age and sex.

A second letter and a short background questionnaire (See Appendix A) was sent to those individuals who returned the postcard and were willing to participate in the study. The cover letter gave a further description of the study as well as outlined the extent of participation required of the subject. The questionnaire contained 12 questions regarding such items as

medical restrictions subjects may have, the typical drive the subject experiences, the seat they currently use, and their height and weight. The results of this last questionnaire were used in making our final selection of subjects to participate in the study.

One hundred and two subjects were selected for measurements in the lab. Their age, sex, and body height were used to select these subjects. Table 2 shows the number of subjects in each of the eight categories which are defined by sex, age, and stature. Sample categories 1-8 were constrained by stature above or below the average height (female = 162.9 cm; male = 175.5 cm) [1]. If subjects were born in 1945, they were considered baby-boomers. Due to the nature of the measurements, subjects were selected with low body weights.

Age	Male		Female	
	1	2	5	6
Baby Boomer (After 1945)	Above N=13	Below N=13	Above N=12	Below N=13
Pre-Baby Boomer (Before 1945)	3	4	7	8
	Above N=13	Below N=13	Above N=13	Below N=12

Table 2 Distribution of laboratory subjects by sex, age group, stature group and sample size.

The additional criterion for selecting forty subjects among the 102 listed in Table 2 for the drive segment of the study was vehicle ownership. Approximately equal numbers of subjects were selected in the same sampling categories as described above (Table 3). Due to the nature of the measurements, subjects with the lowest body weights were selected.

Age	Male		Female	
	1	2	5	6
Baby Boomer (after 1945)	Above N=6	Below N=4	Above N=5	Below N=4
Pre-Baby Boomer (before 1945)	3	4	7	8
	Above N=4	Below N=6	Above N=5	Below N=6

Table 3. Distribution of Drive Subjects by Sex, Age group, Stature group and sample size.

In order to control age distribution, the driving sample group was divided into 10-year subgroups in which subjects were selected equally above and below average height. However, when referring to age in this report the pre- and baby boomer groups will be used.

We limited this selection to drive subjects to individuals who drove mid-sized automobiles because they come from the market segment for the '95 Chevrolet Lumina we used for the test drives. Thus, halo effects due to vehicle package expectations were minimized.

Using this approach, we were able to recruit 30 subjects from the R. L. Polk sample. The remaining 10 subjects were selected from people who expressed interest in participating after hearing about the study from family and friends. While these subjects were selected on sex, age, stature and weight, they were not limited to the type of car they drove. Therefore, there was some deviation to the mid-sized car criterion. Deviation to the mid-size car criterion also occurred due to some discrepancies in the R.L. Polk data. Overall, 30 of the 40 subjects selected drove mid-sized cars (Table 4) and the remaining 10 subjects owned and drove the following types of cars of different sizes, bought prior to 1992 and minivans or trucks.

Buick	Century	1	Mercury	Cougar	1
	Regal	1		Grand Marquis	1
	Reatta	1		Sable	1
Chevrolet			Oldsmobile		
	Cavalier	1		Cutlass Supreme	4
	Lumina	3		Delta 88	1
	Pickup	1		Achieva	1
	Caprice	1		Cutlass Ciera	1
Dodge				Cutlass Cruiser	1
	Intrepid	1		88 Royale	1
	Shadow	1		Aurora	1
Ford			Plymouth		
	Tempo	3		Acclaim	1
	Aerostar	1	Pontiac		
Honda				Grand Am	5
	Accord	4	Subaru		
Hyundai				Legacy	1
	Excel	1			

Table 4. Vehicles owned and driven primarily by drive subjects.

IV. Laboratory Preparation and Subject Measurements

Each subject started with the seat and steering wheel in the same position. The driver's seat was moved to the rearmost, downmost position while the steering wheel was adjusted to the upmost position. All SDT rods were held in their rearmost position so as that subject's clothing would not catch the tips upon entering the seat. Computer files were initialized for each subject, and pressure output from the BPD mat was checked to make certain that all instrumentation was working correctly. If a new pressure mat was installed or the current one was adjusted for wrinkling, the location of the pressure distribution mat in the seat buck was measured. At this time quarter-sized, retro-reflective targets were laid out in the seat buck along with black backgrounds that provided greater contrast for the targets than the subject's skin. This contrast increased the definition of the targets in the video images.

A. Arrival of Subject

Subject folders with the protocol, consent form, anthropometric sheet, lab evaluation, and subject reimbursement form were placed in the conference room where the subject was introduced to the goals of the project. Subjects were greeted at the door and shown into a conference room. The goals of the study were outlined including a brief description of our desired subject group. At this point the laboratory measurement section from the Delphi Interior and Lighting Systems, Human Factors video tape was shown to the subject. If the subject was a "drive subject" subject participation was explained. Both lab and drive subjects were briefed on the contents of the consent form. Throughout the presentation the subject was encouraged to ask questions. After the subject signed the human use consent form (approved by the University Committee on Research Involving Human Subjects, see Appendix A), they were instructed to change into the subject clothing. Each subject was requested to wear low cut shoes and socks. Proper sized black bike shorts and tank tops for the subject were placed in the changing room for their use.

B. Seat Buck Measurements

The subject was escorted into the laboratory and introduced to the staff collecting the data. The subject was instructed to tuck his or her shirt in smoothly around the hips and then to sit in the seat buck. After the seat and steering wheel controls had been demonstrated, the subject was asked to adjust the power seat (fore-aft and vertical only) and steering wheel (tilt only) to positions that were comparable to those used when driving. The subject was asked again after making their initial adjustments to make any changes to the seat. Then, the subject was asked to remain in a fixed but relaxed driving posture with his/her hands at the 10 and 2 positions on the steering wheel. The subject was able to ask questions at any time during the measurements. The SDT rods (Figure 1) were carefully released and then all 16 rod and sleeve points were measured with the Metrecom. Next, the retro-reflective targets with a black background were placed on the following locations, after a skin protectant was applied:

1. Suprasternale

2. Mesosternum
3. Right anterior superior iliac spine (RASIS)
4. Trapezius Point (neck)
5. Scapular Spine (shoulder)
6. Olecranon (elbow)
7. Styloid Process of the Ulna (wrist)
8. Lateral Femoral Condyle (knee)
9. Lateral Malleolus (ankle)

When the position of the SDT rods was recorded, the positions of suprasternale, mesosternum, RASIS and C7 were measured with the Metrecom. Data from the Metrocom, BPD and the seat position transducers were collected without disturbing the subject. When data collection was completed, the infrared lights were turned on and the subject, (if needed) was asked to remove his/her glasses so the right ectocanthus would show clearly in the video anthropometry images. All four camera images were reviewed to ensure that each target was captured by at least two cameras. Once the images were captured correctly, the subject moved from the seat buck to the anthropometric station.

C. Anthropometric Measurements

For the anthropometric measurements the subject was instructed to remove his/her shoes and to step on the scale to measure weight. Then while standing on the floor, the subject was instructed to stand erect with the head in the Frankfort plane position. We measured stature with a traditional anthropometer. Age was also recorded at this time by the lab technician on the anthropometry sheet. The Metrecom had been moved from the seatbuck and positioned on the SAS (Figure 7). The Metrecom axis system was defined using fiducial points on the SAS that defined an axis system (Figure 6).

The subject was then instructed to stand as erect as possible in front of the Metrecom and look straight forward. Points on the maximum right deltoid, maximum left deltoid, RASIS and LASIS were collected. The LASIS and the RASIS were marked by a lab technician while a second technician collected the points. This procedure helped stabilize the subject to prevent postural sway. After these four points were collected the subject sat on the SAS, back against the seatback with his/her knees and elbows joints at 90 degrees with the hands straight out, palms inward. The seat pan height was adjusted to obtain a 90-degree angle at the knee joint. The subject was asked to hold this position while a technician collected the following points with the Metrecom. All points are on the right side of the body unless otherwise noted.

1. Vertex, Sitting Height
2. Ectocanthus, Sitting eye height
3. Suprasternale, Sitting Sternal Notch Height
4. Seat Pan, Sitting Heights
 5. Top of Acromion: Sitting Shoulder Height & Shoulder Elbow L
 6. Bottom of Elbow: Shoulder Elbow L
 7. Back of Elbow: Elbow Finger L
 8. Tip of Longest Finger: Elbow Finger L

9. Right Hip: Hip Breadth
10. Left Hip: Hip Breadth
11. Top of Knee: Knee Height
12. Floor: Knee Height
13. Front of Knee: Buttock-Knee Length
14. Popliteal Fossa: Buttock-Popliteal L
15. Seat Back: Buttock-Knee & Buttock-Popliteal L

The subject was then asked to exit the SAS and points marked by targets on the seatback, seat pan and floor were collected with the Metrecom.

D. Spine Data Collection

The SAS (Figure 7) was converted to collect data for the Spine Model. First the SAS was lowered to its lowest position. Two body pressure mats (BPD), permanently mounted on a board, were rigidly secured to the seat pan. The handles for the BPD mats were connected and checked to assure that the mats were communicating with the computer. A wooden box which protects the BPD handles was placed in position. Notations were made to identify pressure mat locations in the data file. Since the Metrecom had not been moved, the same axis system was used.

To position the subject in the seat, the subject was instructed to sit in the seat, to lean forward and position his/her buttocks back into the seat. This was necessary to position the ischial tuberosities on the BPD mats. The seatbelt was cinched, and the seat pan raised until there was a 105° knee angle. Calves were perpendicular to the floor. The knee stop was adjusted to brace the subject's knees.

The subject was then asked to sit in a neutral posture and the posterior pelvic support was tightened, holding the pelvis in place. XZ coordinates of the chest support were measured and recorded by hand. Data collection included recording the BPD data and then measuring the following points with the Metrecom.

- | | |
|-------------------------|--|
| 1. Right Lumbar Support | 13. T6 |
| 2. Left Lumbar Support | 14. T8 |
| 3. Floor of the SAS | 15. T10 |
| 4. Knee | 16. T12 |
| 5. Hip | 17. L1 |
| 6. RASIS | 18. L2 |
| 7. Shoulder | 19. L3 |
| 8. Suprasternale | 20. L4 |
| 9. Sternum 2 | 21. L5 |
| 10. C7 | 22. S1 |
| 11. T2 | 23. Right Posterior Superior Iliac Spine (RPSIS) |
| 12. T4 | |

All points were taken from the right side of the body unless otherwise indicated. These points were collected in a total of five positions, neutral, extended, slumped 1, slumped 2, and slumped 3. Slumped 1 position was determined by adjusting the chest support 5 centimeters

forward and 5 centimeters down from the neutral posture. When finished, the subject stood up from the SAS. If the subject were a lab subject, he/she filled out the lab evaluation questionnaire and the subject reimbursement form. If the subject were a drive subject, he/she moved into the garage to begin their drive.

V. Drive Protocols and Data Collection

A. 20-Minute Drive

The purpose of the 20-minute drive was to eliminate any halo effects that might occur due to operating a different test vehicle. This drive further gave the subject an opportunity to become comfortable with all the test equipment and procedures.

After the SAS measurements, 5 electromyography electrodes were attached to familiarize the subject with their feel while operating the vehicle. Electrodes were placed on the paraspinal musculature at the level of C6 and the right acromion regions. The ground electrode was placed near the clavicle. The subject was then seated in the car and the electrodes were hooked to the pre-amplifier that optically isolated the subject from the electrical current in the computer. Seat controls and steering wheel were demonstrated by moving each control with the subject in the seat. The subject was then asked to adjust the seat to a comfortable driving position and was informed that he/she could adjust the seat at any time during the drive. The target on the RASIS was checked for proper placement and the seatbelts fastened. Since this was the first drive, the subject was instructed to ask questions at any time during the drive. The subject was also to report any physical discomfort or any discomfort from the environment.

The route from the laboratory in Lansing, Michigan proceeded south along US 127 to Holt Road exit. The subject took this exit and turned around to rejoin US 127 proceeding north. The subject exited US 127 at Grand River and returned to the laboratory. The total time for this drive was typically 20 minutes.

When the subject finished the drive and was still seated in the test vehicle, the Ride Technician (RT), collected data from EMG, video anthropometry, seat position, and BPD. The Seat Evaluation Questionnaire and the Post Drive Questionnaire were both explained and then administered. Subjects were encouraged to ask questions at any time. After exiting the vehicle, the subject filled out the Evaluation Questionnaire.

B. Fixed Seat Back Drive

The fixed seat back drive, approximately 90 minutes long, was taken with the seat back angle in one of two positions: reclined or upright. The two positions were upright (15° from vertical) and reclined (30° from vertical). The sequences for positions of the seat, upright or reclined, were randomized for all 40 drive subjects. After changing into the same black tank tops and biking shorts as previously used in the laboratory and on their 20-minute drive, subjects went into the laboratory where targets and the EMG electrodes were applied. After all the electrodes were placed on the subject, a computer was used to detect the muscle activity in each of the regions to insure proper placement. Once proper placement was insured the frequencies were

recorded as a baseline for the level of muscle activity. After the electrodes were attached an image of the back was saved on disk for electrode placement reference for the next visit.

With the subject seated in the vehicle, the Ride Tech (RT) explained the seat controls and the fixed position of the seatback. Even though the seat back angle was fixed, the subject was encouraged to use any of the other seat adjustments throughout the drive. Subjects were also instructed to tell the RT if they were feeling any discomfort during the drive such as physical discomfort or any discomfort stemming from the environment, (i.e. noise, vibration, etc.). Data were collected according to the protocol described in Table 5.

Drive Time in minutes	0	15	30	45		50	65	80	95
EMG	X	X	X	X	Change seat back	X	X	X	X
Seat Position	X		X	X	without subject	X		X	X
BPD	X		X	X	exiting car	X		X	X
Video Anthropometry	X		X	X		X		X	X
Verbal Questionnaire			X	X		X		X	X
Written Questionnaire				X					X

Table 5. Fixed seat back drive data collection protocol.

After 45 minutes in one position, the subject stopped the test vehicle at a predetermined spot off the highway and the Ride Tech collected data in the following order: Verbal Questionnaire, EMG, Video Anthropometry, Seat Position, and BPD data. Then the seat was set into the new position without the subject leaving the seat. The subject drove back to the lab in the second seat position. Once back at the lab the data were again collected in the same order.

The route for the drive proceeded north along US 127 to Interstate 69 West. The subject drove west to exit 81 where he/she turned onto Interstate 96 traveling west. They proceeded on I96 to exit 59 (Clarksville, MI) where they exited and stopped. At this time, another set of data was collected just prior to changing the angle of the seat back. This trip usually took approximately 45 minutes. The return trip to Lansing followed the same route to the Grand River/Saginaw exit on US 127 south. The subject then proceeded to the laboratory. The total time for the drive took approximately 1 1/2 hours. This route was followed in morning and afternoon drives.

Data (Verbal Questionnaire, EMG, Video Anthropometry, Seat Position, and BPD) were collected at the beginning of the drive, 30 minutes into the drive, and before the back angle was changed. After changing the back angle, the data were again collected, then again after 30 minutes and at the end of the drive. Data were also collected if, at any time during this drive, the subject reported any discomfort to the Ride Tech. The Seat Evaluation Questionnaire was given after each 45-minute fixed back rest drive. The Post Drive Questionnaire was administered at the end of the drive before the subject exited the test vehicle. Once the subject exited the vehicle, he/she filled out the Evaluation Questionnaire.

C. Free Drive

For the Free Drive the subject was in full control of all seat controls unlike the Fixed Seat Back Drive. Once again, the subject was required to wear black bike shorts, tank top and low cut shoes. Retro-reflective targets were placed on the same landmarks. EMG electrodes were placed in the same position as in the Fixed Back Angle Drive with the aid of the ghost image of the electrodes taken during the subject’s previous visit.

After the preparation was complete in the lab the subject entered the test vehicle. Once again, the Lab Technician demonstrated the seat controls and notified the subject that he/she could change the seat position anytime during the drive. The RASIS target was applied to the subject. The subject was instructed to report any discomfort experienced during the drive as mentioned in the Fixed Seat Back Angle Drive. During the free drive, six different measurements were collected at distinct intervals (Table 6). Also, a continuous video of the driver was recorded. EMG was collected every 10 minutes.

Drive Time in minutes	0	10	20	30	40	50	60	70	80	90	100	110	120
EMG	x	x	x	x	x	x	x	x	x	x	x	x	x
Seat Position	x			x			x			x			x
BPD	x			x			x			x			x
Video Anthropometry	x			x			x			x			x
Verbal Questionnaire	x			x			x			x			x
VCR Recording	x	-----											x
Written Questionnaire													x

Table 6. Free drive data collection protocol.

The route of the Free Drive was dependent on the position of the sun in the sky due to the light sensitivity of the cameras. Two routes were designed around the position of the sun, one for the morning and one for the afternoon.

In the morning, the route took US 127 to Jackson. They turned onto I-96 proceeding west to I-69 north (near Marshall, MI.) They took I-69 east to exit 90, leading to US 127 south to the Jolly Road exit in Lansing, MI. They turned around and took US 127 north to the Grand River/Saginaw exit near the laboratory and returned to the laboratory. The total time for this drive was approximately 2 hours.

The afternoon drive took US 127 to I-96 East and proceeded to Brighton, MI. They took US 23 north to exit 117A outside of Flint, MI to connect with I-69 west. They proceeded along I-69 until reaching US 127 south. They drove south on US 127 to exit at Grand River/Saginaw near the laboratory. The total time from laboratory to laboratory was 2 hours.

When the subject adjusted the seat to a comfortable position, the RT collected the Verbal Questionnaire, EMG, Video Anthropometry, Seat Position, BPD and then the VCR was turned on continuously to record body movement from camera #4. During the drive data were collected whenever the subject verbally indicated a level of discomfort. No data were collected during the

first 30 minutes of the drive. This allowed the driver to become acquainted with the seat and controls. After the first thirty minutes, data were collected if the subject indicated any discomfort or adjusted the seat. If no other indications or movements occurred, data were collected 1 hour after the last indication and/or adjustment. If there was no indication of discomfort from the subject and the seat was not adjusted during the drive, data were collected 30 minutes into the drive and 1 1/2 hours into the 2-hour drive. If after this time the subject indicated discomfort and/or adjusted the seat, then data were collected at that time and the 1 1/2-hour mark for data collection was ignored. Time was always noted so that there was never more than 1 hour between data collections. As with all the drives, data were collected at the end of the drive. After the final data collection, while the subject was still in the vehicle, the RT administered the verbal questionnaire, the Seat Evaluation Questionnaire, and the Post Drive Questionnaire. Once the subject was out of the vehicle the subject filled out the Evaluation Questionnaire.

VI. Summary of Reports and Expected Results

Reports on the following topics will be delivered to Delphi Interior & Lighting Systems for the 1994/1995 MSU/Delphi research program. As these technical reports are written, they will be assigned a number to index all technical reports coming from the Ergonomics Research Laboratory at MSU. This numbering system will first state the laboratory name followed by the type of report, year and sequence number unique to each report. For example, ERL-TR-95-001 will be our first report to Delphi Interior and Lighting Systems (formerly Inland Fisher Guide Division of General Motors Corporation). Each report will follow the general outline of a scientific paper described by Robert A. Day, How to Write and Publish a Scientific Paper. In general, the outline of the report will be Introduction, Methods and Materials, Results and Discussion sections.

DATA ANALYSIS

- a) Pelvis Model: Location of H-point and D-point in the seated driver's anatomy in a seat buck and a mid-sized sedan. (Items B.I.1, B.II.3, C.II.1, C.III.1,)
- b) Spine Model: shape and location of the lumbar curve in seated driver in a mid-sized sedan and seatback foam deflection, seat cushion foam deflection and driver's back contour in a seatbuck and in a mid-sized sedan. (Items B.I.2-4, B.II.1-2, C.II.2, C.III.2).
- c) Driving posture: size and orientation of the seated driver's contact pressures; seat position and steering wheel position in a mid-sized sedan; and joint angles of a driver in a mid-sized sedan. (Items B.I.5-8, C.II.3-8, C.III.3-8).
- d) Driver muscle Activity: Seated driver's muscle activity during two-hour drives in a mid-sized sedan. (Items C.II.9, C.III.9)
- e) Comfort and Posture Experimental Design: Anthropometric and market sample data to investigate driver comfort and posture; body language and questionnaires as tools to investigate posture. (Items A.I.1-2, A.II.1-2, A.III.1-2)
- f) Two-dimensional seat design template: developed from the knowledge and results reported in the above reports. (Items D.1.-3.

Given below is a specific list of items that will be reported from the data collected. At the end of each item description is a letter in brackets which corresponds to the summary of deliverables listed above. Reports will be delivered according to the above list of deliverables. Each report will contain the results of the items listed below.

A PLAN AND OPERATION OF POSTURE COMFORT INVESTIGATION

I Experimental Design

1. Complete description of experimental design and research protocol. (e)
2. Comparison of actual with proposed design for market representation and balance design for age, sex, and body size. (e)

II Anthropometric Measurements

1. Complete anthropometric descriptions of all subjects. This is essential for extrapolating data to the general population. (e)
2. Anthropometric measurements are required for all biomechanical models. (e)

III Comfort Measurements

1. Questionnaires and their results from verbal, post-drive and seat evaluation. (e)
2. Body language as a tool to independently evaluate driver comfort. (e)

B LABORATORY MEASUREMENTS

In the laboratory, 100 subjects between the age of 25-75 years were selected to represent above and below average height for five age categories. The following describes the reports that will be generated from these studies.

I Seatback

All subjects were asked to choose the most comfortable seat position for a mid-size automobile. From this data we will provide the following:

1. Pelvic orientation, including the location of H-point, D-point and ASIS. (a)
2. Seatback foam deflection. (b)
3. Subject back contour. (b)
4. Test spinal model for predicting lumbar curve, using step 4 to provide a check. (b)
5. Seat deflection estimated from the D-point calculation. (b)
6. Pressure distribution in the seat cushion, including area of contact, pressure peaks, ischial tuberosity locations, leg-splay angles, left and right thigh contact areas. (c)
7. Average seat position and descriptions according to age, sex, and body size. (c)
8. Subject posture including joint angles of all major body segments. (c)

II **SAS**

1. Data that describes spinal contour for two upright and three slumped postures. (b)
2. Develop a model that describes the geometric relationship between spinal contour and the position of the thorax relative to the pelvis. (b)
3. Precise measurements of the ASIS, D-point, H-point and pelvic positions for all subjects. (a/b)

III **TOOLS**

1. Buttock form to calibrate pressure/deflection of seat cushion. (c)

C **DRIVES**

Forty of the 100 subjects were selected for drives, based on age, sex, height and past automobile purchases. All drive subjects had the laboratory measurements completed before the first drive. Each drive subject took 3 drives in an instrumented vehicle laboratory, 1995 Lumina, accompanied by a ride tech on each drive.

I **Drive 1**

The first drive provides the subject an opportunity for acclimating themselves to the car laboratory and to orient themselves with the car, especially the interior and the seat. The first drive serves to reduce the learning curve so that more accurate data is collected on the following drives. In addition, it serves as the base-line for the seat evaluation questionnaire.

II **Drive 2**

In this drive the seatback angle is fixed into an upright and a reclined angle. The subject drives for 45 minutes with the seatback in one angle and 45 minutes with the seatback in the other angle. The order of which position is first (upright or reclined) was randomized. We will provide the following data for each seatback orientation (upright or reclined):

1. Pelvic orientation, including the location of H-point, D-point ASIS and PSIS as well as a comparison between the two seatback angles. (a)
2. Predicted lumbar geometry and comparison to lumbar support position and seatback orientation. (b)
3. Pressure distribution in the seat cushion, including area of contact, pressure peaks, ischial tuberosity locations, leg-splay angles, left and right thigh contact areas. (c)
4. Pressure distribution in the seatback, including area of contact and pressure peaks as well as a description of the peak pressures relative to the lumbar support location. (c)
5. Average seat position (seat horizontal and vertical position, seatback angle, lumbar support position) and descriptions according to age, sex, and body size as well as comparisons between the upright and reclined positions. (c)
6. Steering wheel position and correlation to height, age, sex and the orientation of the seatback. (c)
7. Descriptions of seat position adjustments throughout the drive and a comparison for each seatback orientation. (c)
8. Subject postures including joint angles of all major body segments throughout the drive and a comparison between the two seatback orientations. (c)

9. EMG muscle activity, including correlation with body posture, predicted lumbar geometry, seat position and seatback orientation (upright or reclined). (d)

III Drive 3

The subject is allowed to adjust all seat controls to their most comfortable position and to alter the seat position at any time during the drive. The following information will be provided:

1. Pelvic orientation, including the location of H-point, D-point ASIS and PSIS as well as a comparison to the second drive. (a)

2. Predicted lumbar geometry and comparison to lumbar support position and seatback orientation. (b)

3. Pressure distribution in the seat cushion, including area of contact, pressure peaks, ischial tuberosity locations, leg-splay angles, left and right thigh contact areas as well as a comparison to the second drive. (c)

4. Pressure distribution in the seatback, including area of contact and pressure peaks as well as a description of the peak pressures relative to the lumbar support location and a comparison to the second drive. (c)

5. Average seat position (seat horizontal and vertical position, seatback angle, lumbar support position) and descriptions according to age, sex, and body size as well as comparison to the second drive. (c)

6. Steering wheel position and correlation to height, age, sex and seatback orientation as well as a comparison to the second drive. (c)

7. Descriptions of seat position adjustments throughout the drive and a comparison to the second drive. (c)

8. Subject postures including joint angles of all major body segments throughout the drive and comparison to the second drive. (c)

9. EMG muscle activity, including correlation with body posture, predicted lumbar geometry, seat position and comparison to the second drive. (d)

D TWO-DIMENSIONAL TEMPLATE MODIFICATION

The Oscar template will be modified to represent the pelvis, e.g. the relationship between H-point and D-point, include a lumbar curve based upon coupled motions of the chest and pelvis, and separate the thigh from the pelvis. Comfort positions of this template will be developed in 1996. (f)

1. AUTOCAD file of existing OSCAR
2. AUTOCAD file of new template "ERL"
3. Physical design template of "ERL"

VII. List of References

[1] Gordon CC, Churchill T, Clauser CE, Bradtmiller B, McConville JT, Tebbetts I, Walker TA. 1988 Anthropometric Survey of US Army Personnel: Methods and Summary Statistics. Technical Report Natick/TR-89/044. United States Army Natick, Research, Development and Engineering Center, Natick, MA., 1989.

APPENDIX A

Correspondence with Subjects (including Consent Form)

1. **Initial Contact Letter** - The first letter that all Polk Subjects received explaining the study. A postcard was enclosed with the letter and interested parties were instructed to reply by returning the postcard. (p. 38)
2. **Second Contact Letter** - This letter was sent to subjects who indicated an interest in this study. It further explained the study. Background Questionnaire enclosed. (p. 39)
3. **Background Questionnaire** - This purpose of this questionnaire was to gather more information on subjects interested in the study. Potential subjects were questioned about physical limitations that would prohibit them for driving for the required two hours. The questionnaire also asked subjects about their typical drive habits, the type of seat in their vehicle and height and weight. (p. 40)
4. **Confirmation Letter 1** - This letter was sent to confirm the dates and times of measurement session and drives which were arranged via telephone. A map with written instructions to the lab was included as well as a brief description of the measurement session and the drives. (p. 41)
5. **Confirmation Letter 2** - This letter was sent to confirm the date and the time of the measurement session which was established via telephone. A map with instructions to the lab was included as well as brief description of the measurement session. (p. 42)
6. **Consent Form 1** - A contractual agreement that informed the individual of his/her rights and responsibilities as a subject participating in the laboratory measurement session and the drives. (p. 43)
7. **Consent Form 2** - A contractual agreement that informed the individual of his/her rights and responsibilities as a subject participating only in the laboratory measurement session. (p. 44)

September 23, 1994

«Title» «Fname» «Lname»
«Address1»
«City», «State» «Zip_Code»-«Zip__4»

Dear «Title» «Lname»,

Are you comfortable in your car seat? As you know from experience, an uncomfortable car seat can be a source of stress and fatigue. The Ergonomics Research Laboratory at Michigan State University is investigating comfort in automotive seating. We are seeking individuals who have purchased a new vehicle in the last three years to participate in our study. Your participation will help us develop a model that will lead to the design of more comfortable automotive seats.

Your participation will require one or four visits, once a week, to our lab. On your first visit we will take some physical measurements, such as height, back length and shape, etc. You will also take a brief test drive if you are participating in the complete study. The next three sessions will each consist of two-hour drives on the highway in our test vehicle. On each drive, you will be accompanied by a laboratory technician who will guide you and collect data throughout the drive. Data collection in the car is unobtrusive so you will be unaware when it occurs. When each drive is finished, you will complete a short questionnaire and then you may leave. You will be paid **\$75.00** per visit after the completion of your participation in our study.

Please return the enclosed postcard if you or anyone in your household, age 25 or older, is interested in participating in this study. If you have any questions, please contact Maria Eppler at (517) 487-1702.

Sincerely,

Maria Eppler
Ergonomics Research Laboratory
Michigan State University
742 Merrill St.
Lansing, MI 48912

Enclosure

October 31, 1994

«Title» «Fname» «Lname»

«Address1»

«City», «State» «Zip_Code»-«Zip__4»

Dear «Title» «Lname»,

Thank you for your interest in our automotive seating comfort study. We appreciate your taking time to respond to our inquiry. Enclosed is a confidential questionnaire that will give us general information about you that will assist us in our selection of subjects for this study. We want to select a group of subjects who represent a range of body sizes. Current automotive seating must accommodate a range of sizes and shapes that are in the general population. After you have completed the questionnaire, please return it using the enclosed stamped envelope. When we receive your survey we will call you to set up a time to come into our laboratory. We will begin measuring subjects in mid-October and we will continue driving through mid-December weather permitting.

As a reminder, there are two options regarding your participation in this study. Your participation will require either one or four visits to our lab. During the initial visit, we will take some body measurements that are used in seat design. Individuals participating in the driving portion of the study will also go for a brief test drive. Each of the next three sessions will consist of a two-hour highway drive in our test vehicle, and completion of a short questionnaire. You will be reimbursed for your time as mentioned in our previous letter.

We appreciate you taking the time to fill out the enclosed questionnaire and look forward to your participation in this investigation. If you have any questions, contact me at (517) 487-1702.

Sincerely,

Maria Eppler
Ergonomics Research Laboratory
Michigan State University
Lansing, MI 48912

Date _____ ID#

SUBJECT BACKGROUND

Please answer the following questions and then return in the postage paid envelope

1. Do you currently have any restrictions that prevent you from driving a car for two hours? NO YES

2. Have there been any medical restrictions on your physical activities in the past 6 months? NO YES
If YES, please explain:

3. Is your typical drive made primarily on: Urban/City roads Rural roads Highways

4. How many miles is your typical trip? Less than 5Mi 5-20Mi 20-50Mi Over 50Mi

5. How often do you take a two-hour drive? Once a Day Once a Week Once a Month Once every 3 to 6 Months Once a Year

6. What seat style does the car you drive most frequently have? Bench Split Bench Bucket

7. On the following scale please mark (/) how you feel about this seat.

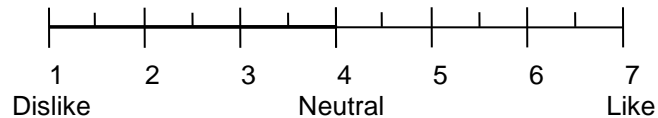

8. Do you have power seat adjustments? NO YES

9. Do you have an adjustable lumbar support? NO YES If yes, is it... Manual Power

10. Do you use any seating aids (cushions, bead mats, etc.) for personal comfort in your car seat? NO YES
If YES please describe:

11. What is your height? ____ft. ____in. Weight? _____lbs.

12. Indicate what day(s) and Time(s) you would **NOT** be available to participate.

	Monday	Tuesday	Wednesday	Thursday	Friday
Morning					
Afternoon					

Please return this questionnaire in the enclosed stamped envelope.

January 24, 1995

Ms. Jane Doe
111 Main St.
Lansing, MI 48912

Dear Ms. Doe,

Thank you for agreeing to participate in the seating comfort study. Your scheduled times for the lab and test drives are as follows:

Thursday, January 26, from 10:00 a.m. to 12:00 p.m.

Tuesday, January 31 from 8:30 a.m. to 11:00 a.m.

Thursday, February 2 from 8:30 a.m. to 11:30 a.m.

A map to our laboratory is included with this letter. Parking is provided in a free lot right outside our building. If you are unable to make any of these times or if you would feel uncomfortable driving due to weather conditions, please contact us as soon as possible so other arrangements can be made. If calling after hours, you may leave a message.

Your first visit to the lab will consist of gathering physical measurements, such as height, back length, etc. and a brief orientation of the test drive. None of the testing procedures are harmful in any way. We will provide clothing for the testing, but we ask that you wear comfortable shoes that do not cover your ankles.

After the initial measurements in the first visit are collected, the next two sessions will consist only of test drives. You will be accompanied by a trained technician who will guide you on the drive and collect data. The data collection in the car is unobtrusive so you will be unaware it is occurring. When the drive is complete, there is a questionnaire to fill out and then you are free to leave. The total time is approximately 2-3 hours per visit. You will be paid \$75.00 per visit. The payment will be in the form of a check mailed from Michigan State University at the completion of your participation in this study. We will need your social security number to complete the payment.

If you have further questions, please contact me at (517) 487-1702.

Sincerely,

Maria Eppler
Ergonomics Research Laboratory
Michigan State University
Lansing, MI 48912

March 13, 1995

Mr. John Doe
111 Main St.
Lansing, MI 48912

Dear Mr. Doe,

Thank you for agreeing to participate in the seating comfort study. Your scheduled time for measurements is as follows:

Wednesday, March 15, from 8:30 a.m. to 9:30 a.m.

A map to our laboratory is included with this letter. Parking is provided in a free lot beside our building. If you are unable to make this time, please contact us as soon as possible so other arrangements can be made.

Your visit to the lab will consist of gathering physical measurements, such as height and back length. None of the testing procedures are harmful in any way. We will provide clothing for the testing, but we ask that you wear comfortable shoes that do not cover your ankles.

The total time for lab measurements is approximately 1 hour. You will be paid \$75.00 for your participation. The payment will be in the form of a check mailed from Michigan State University at the completion of your participation in this study. We will need your social security number to activate the payment.

If you have further questions, please contact me at (517) 487-1702.

Sincerely,

Maria Eppler
Ergonomics Research Laboratory
Michigan State University
Lansing, MI 48912

Driver Comfort Study Informed Consent

I, _____, voluntarily agree to participate in a research program at Michigan State University that is investigating driver comfort on the highway. Upon arriving at the research laboratory, I received instruction from laboratory personnel that completely described the car, all instrumentation, experimental procedures, and what was expected of me. Each of the three visits will consist of collecting measurements in the laboratory with professionals, collecting measurements while driving in the car with a laboratory technician, and answering questionnaires. I will be paid \$75 per visit for my participation.

I understand that data will be collected during the drive by a laboratory technician seated in the rear of the car. All information whether collected by electronic instrumentation on the computer, written by me, or spoken by me is coded so that my identity is unknown. Any information that associates my identity with my identification code will be kept secure and available only to research laboratory personnel on a need-to-know basis. Any subsequent report of research findings will describe group results with individual subject anonymity guaranteed.

I understand that as the driver of the car, I am responsible for obeying the laws of the State of Michigan. Thus, as the vehicle operator, traffic violations are my responsibility, and any motor vehicle accident in which I am ruled at fault by police will be my responsibility. If I, or the laboratory technician, feel that driving conditions are unsafe for any reason, I will stop the drive at that point and transportation back to the laboratory will be provided as necessary.

I understand that if I am injured as a result of my participation in this research project, Michigan State University will provide emergency medical care if necessary. I further understand that if injury is not caused by the negligence of MSU, I am personally responsible for the expense of this emergency care and any other medical expenses incurred as a result of this injury.

I further understand that I will not be required to pay for any expenses incurred by the research except in the cases of motor vehicle accident or medical care as previously described in this document.

I freely consent to participate in this research program and understand that my participation is voluntary. I may refuse to participate in certain procedures or answer certain questions or may discontinue the experiment at any time without penalty or loss of benefits to which I am otherwise entitled.

(Subject Signature)

(Date)

(Laboratory Witness)

Driver Comfort Study Informed Consent

I, _____, voluntarily agree to participate in a research program at Michigan State University that is investigating driver comfort in the Ergonomics Research Laboratory. Upon arriving at the laboratory, I received instruction from laboratory personnel that completely described all instrumentation, experimental procedures, and what was expected of me. I understand that my visit will consist of measurements in the laboratory and answering questionnaires. I will be paid \$75 per visit for my participation.

I understand that data will be collected in the lab by the lab technicians. All information whether collected by electronic instrumentation on the computer, written by me, or spoken by me is coded so that my identity is unknown. Any information that associates my identity with my identification code will be kept secure and available only to research laboratory personnel on a need-to-know basis. Any subsequent report of research findings will describe group results with individual subject anonymity guaranteed.

I understand that if I am injured as a result of my participation in this research project, Michigan State University will provide emergency medical care if necessary. I further understand that if injury is not caused by the negligence of MSU, I am personally responsible for the expense of this emergency care and any other medical expenses incurred as a result of this injury.

I further understand that I will not be required to pay for any expenses incurred by the research except as previously described in this document.

I freely consent to participate in this research program and understand that my participation is voluntary. I may refuse to participate in certain procedures or answer certain questions or may discontinue the experiment at any time without penalty or loss of benefits to which I am otherwise entitled.

(Subject Signature)

(Date)

(Laboratory Witness)

APPENDIX B

Questionnaires

1. **Measurement Session Evaluation Questionnaire** - Administered to the subjects who participated only in the Measurement Session. Subjects evaluated the test clothing, the laboratory staff and test procedures. Subjects were also asked to make suggestions that would improve the study. (p. 47)
2. **Evaluation Questionnaire for Fixed Seat Back Angle Drive** - This questionnaire allowed the subject to evaluate the staff and test procedures. Asked the subject to identify any factors that may have influenced his answers. The subject was also asked to make suggestions that would improve the study. (p. 48)
3. **Free Drive Evaluation Questionnaire** - This questionnaire allowed subjects to evaluate test clothing, procedures, and staff. Subjects were asked for suggestions that would improve the study. (p. 49)

Fixed Seat Back Angle Drive Evaluation

Date: _____ ID#
m d y

1 Did the Ride Tech work in a professional manner? YES NO

Please Comment:

2 Did any procedures used during the testing make you uncomfortable? YES NO

Please Comment:

3 Were your responses to the written and/or verbal questions excessively influenced by the study and/or its personnel? YES NO Please Comment:

4 Please let us know if there is any way in which we can improve our study:

Thank you !

Free Drive Evaluation Questionnaire

Date: _____ ID#
m d y

1. Fit and feel of the Tank Top *(Circle as many answers as are appropriate)*

- Too Loose Good Fit Too Tight Scratches Clings
- Discomfort in seams Irritation due to Label Doesn't Breathe

Please rank the Tank Top overall...

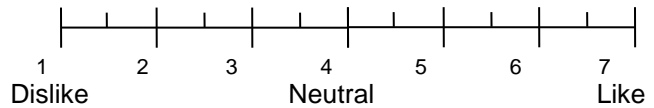

2. Fit and feel of the Bike Shorts *(Circle as many answers as are appropriate)*

- Too Loose Good Fit Too Tight Scratches Clings
- Discomfort in seams Irritation due to Label Doesn't Breathe

Please rank the Bike Shorts overall...

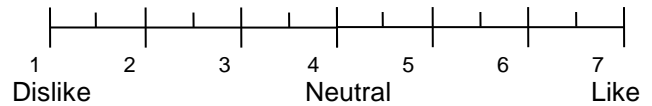

3. Did the Ride Techs work in a professional manner? YES NO

Please Comment: _____

4. Did any procedures used during the testing make you uncomfortable? YES NO

Please Comment: _____

5. Please let us know if there is any way in which we can improve our study: _____

Thank you !

APPENDIX C

Map of Drives:

